

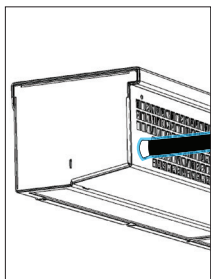

## Typeoverzicht BlueSeal Original

Lengte	Behuizing	Montagebeugel	Kabelpositie		Spanning	Kabelspecificaties	
Lengte van luchtgordijn (mm)	O = Original	R = Regulier E = Omhullend S = Roestvrij staal	L = Links R = Rechts	F = Voor S = Zijkant B = Achter	12V of 24V	Kabellengte (m)	Kabeldikte in mm <sup>2</sup> N = Normaal = 2.5mm <sup>2</sup> T = Dik = 4mm <sup>2</sup> F = Plat = 2.5mm <sup>2</sup>
Voorbeeld van type aanduiding van 2430mm BlueSeal Origineel luchtgordijn, met Reguliere montagebeugel, met voedingskabel gepositioneerd aan de Rechterkant, Achterkant, 24V, 5 meter lange Normale kabel							
2430-*	O-	R-	R	B-	24-	5	N

### Kabelposities



Links voor (LF)  
O-[.]-LF-[...]

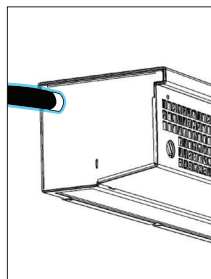

Links zijkant (LS)  
O-[.]-LS-[...]

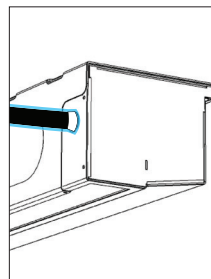

Links achter (LB)  
O-[.]-LB-[...]

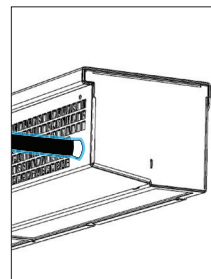

Rechts voor (RF)  
O-[.]-RF-[...]

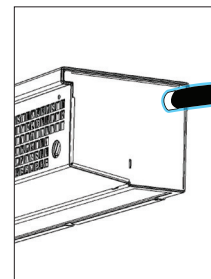

Rechts zijkant (RS)  
O-[.]-RS-[...]

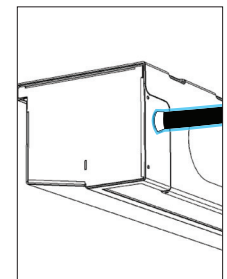

Rechts achter (RB)  
O-[.]-RB-[...]

\* BlueSeal-luchtgordijnen kunnen op maat worden gemaakt op basis van de afmetingen van uw voertuig, met een maximale lengte van 2,430mm.

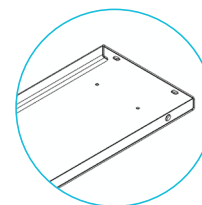
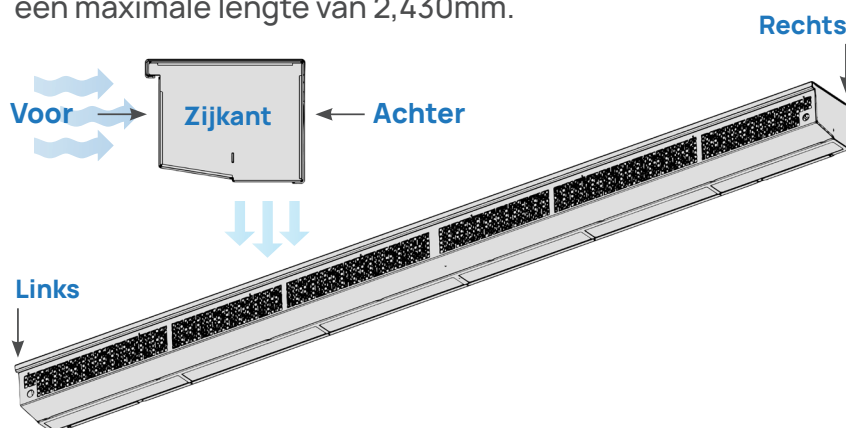

Reguliere montagebeugel

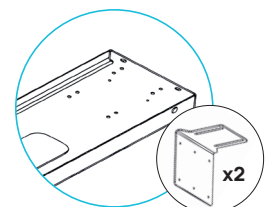

Roestvrij stalen beugel voor roldeur

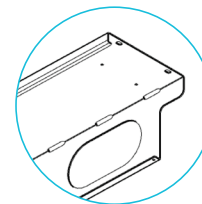

Omhullende montagebeugel