

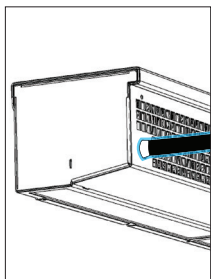

Typeoverzicht BlueSeal Original

Lengte	Behuizing	Montagebeugel	Kabelpositie		Spanning	Kabelspecificaties	
Lengte van luchtgordijn (mm)	O = Original	R = Regulier E = Omhullend S = Roestvrij staal	L = Links R = Rechts	F = Voor S = Zijkant B = Achter	12V of 24V	Kabellengte (m)	Kabeldikte in mm ² N = Normaal = 2.5mm ² T = Dik = 4mm ² F = Plat = 2.5mm ²
Voorbeeld van type aanduiding van 2430mm BlueSeal Origineel luchtgordijn, met Reguliere montagebeugel, met voedingskabel gepositioneerd aan de Rechterkant, Achterkant, 24V, 5 meter lange Normale kabel							
2430-*	O-	R-	R	B-	24-	5	N

Kabelposities



Links voor (LF)
O-[-]-LF-[-]

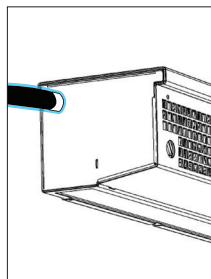

Links zijkant (LS)
O-[-]-LS-[-]

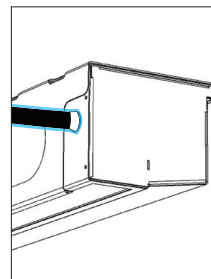

Links achter (LB)
O-[-]-LB-[-]

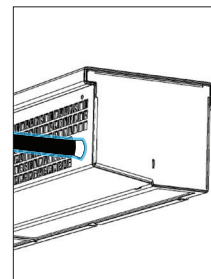

Rechts voor (RF)
O-[-]-RF-[-]

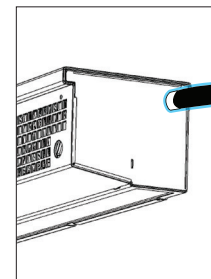

Rechts zijkant (RS)
O-[-]-RS-[-]

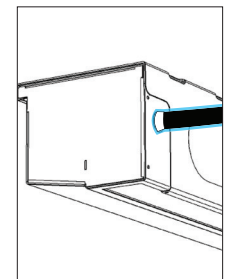

Rechts achter (RB)
O-[-]-RB-[-]

* BlueSeal-luchtgordijnen kunnen op maat worden gemaakt op basis van de afmetingen van uw voertuig, met een maximale lengte van 2,430mm.

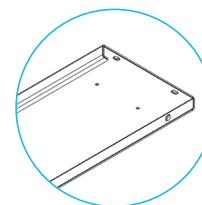
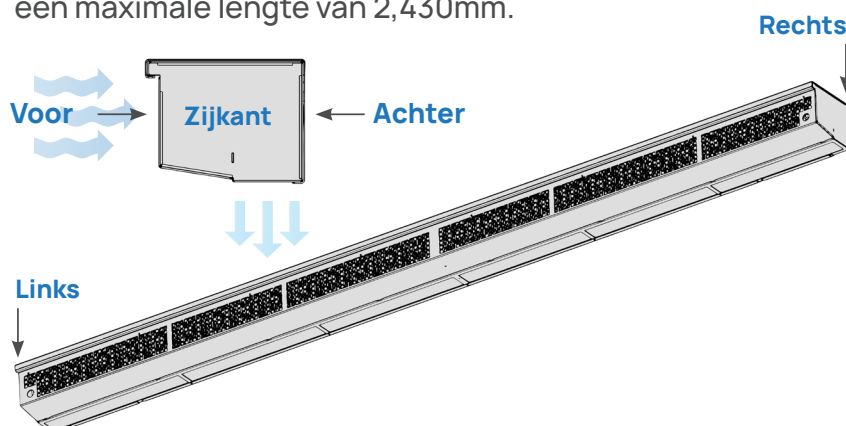

Reguliere montagebeugel

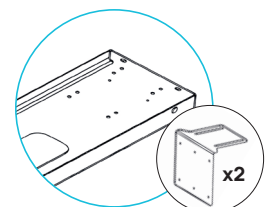

Roestvrij stalen beugel voor roldeur

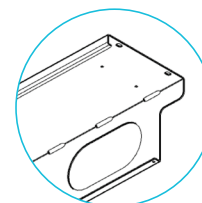

Omhullende montagebeugel